



28.0×21.5×35.0(mm)

特性

15A 触点切换能力,

多种类型, 多种引出端形式

Features

15A switching capability

1.5KV dielectric strength(between coil and contacts)

Various terminals available

Various sockets available

触点参数 Contact Ratings	
接触形式 Contact Form	1C 2C 3C
触点材料 Contact Material	AgCdO
接触电阻 Contact Resistance	100mΩ(1A 6VDC)
触点负载(阻性) Contact Load (resistive load)	1C: 15A 250VAC/30VDC 2C 3C: 10A 250VAC/30VDC
最大切换电压 Max.Switching Voltage	250VAC/30VDC
最大额定切换电流(阻性) Max.Rated Switching Current (Resistive Load)	15A(1C) 10A(2C 3C)
最大切换功率 Max.Switching Power	3750VA/450W
机械耐久性 min Mechanical Endurance min	1×10 ⁷ ops
电耐久性 min Electrical Endurance min	1×10 ⁵ ops

线圈参数 Coil Rating					23℃	
额定线圈功率 Nominal Operating Power		1C 2C: DC:0.9~1.1W AC:1.2~1.8VA 3C: DC:1.4W AC:2VA				
额定电压 Rated Voltage	动作电压 Operate Voltage	释放电压 Release Voltage	最大电压 Max. Voltage	线圈电阻 Coil Resistance		
				1C 2C	3C	
5VDC	4.00VDC	0.50VDC	5.5VDC	27.5× (1±10%) Ω		
6VDC	4.80VDC	0.60VDC	6.6VDC	40× (1±10%) Ω	26× (1±10%) Ω	
12VDC	9.60VDC	1.20VDC	13.2VDC	160× (1±10%) Ω	107× (1±10%) Ω	
24VDC	19.20VDC	2.40VDC	26.4VDC	650× (1±10%) Ω	410× (1±10%) Ω	
48VDC	38.4VDC	4.80VDC	52.8VDC	2600× (1±15%) Ω	1700× (1±10%)Ω	
110VDC	88.0VDC	11.0VDC	121VDC	11000× (1±15%) Ω	8500× (1±15%)Ω	
额定电压 Rated Voltage	动作电压 Operate Voltage	释放电压 Release Voltage	最大电压 Max. Voltage	线圈电阻 Coil Resistance		
				1C 2C	3C	
6VAC	4.8VAC	1.8VAC	6.6VAC	11.5× (1±10%) Ω	6.7× (1±10%) Ω	
12VAC	9.6VAC	3.6VAC	13.2VAC	46× (1±10%) Ω	24× (1±10%) Ω	
24VAC	19.2VAC	7.2VAC	26.4VAC	184× (1±10%) Ω	100× (1±10%) Ω	
48VAC	38.4VAC	14.4VAC	52.8VAC	735× (1±10%) Ω	400× (1±10%) Ω	
120VAC	96.0VAC	36.0VAC	132VAC	4500× (1±15%) Ω	2300× (1±15%)Ω	
220/240VAC	176VAC	72.0VAC	264VAC	14400× (1±15%) Ω	8650× (1±15%)Ω	

性能参数 Specifications		
绝缘电阻 Insulation Resistance		500MΩ(500VDC)
介质耐压 Dielectric Strength	触点与线圈间 Between coils and contacts	1500VAC 1min
	断开触点间 Between open contacts	1000VAC 1min
动作时间（额定电压下） Operate Time (Below Rated Voltage)		≤25ms
释放时间（额定电压下） Release Time (Below Rated Voltage)		≤25ms
线圈温升（额定电压下） Coil Temperature Rise(Below Rated Voltage)		≤60K
冲击 Shock	稳定性 Stability	98m/s ²
	强度 Strength	980m/s ²
振动 Vibration		10Hz~55Hz 1mm double-amplitude
湿度 Humidity		98%RH,40℃
环境温度 Ambient Temperature		-40 ℃ to 70℃
重量 Weight		1C 2C : About 37g 3C : About 55g
引出端方式 Terminal Type		PCB Plug-in

备注：以上值均为初始值。 Note: the above values are the initial value.

订货标记示例 **Ordering Code**

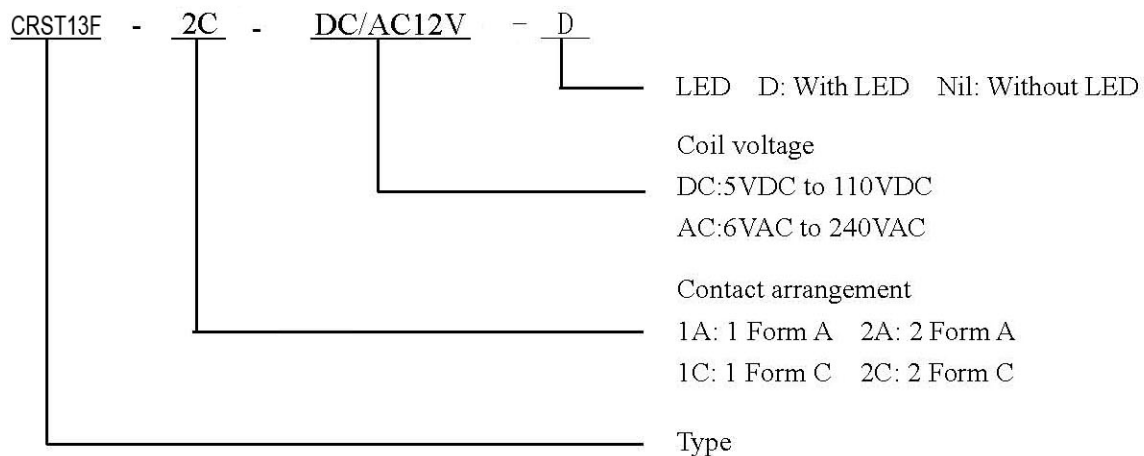

OUTLINE DIMENSIONS, WIRING DIAGRAM AND PC BOARD LAYOUT

Unit: mm

CRST13F-1C/2C/3C

Outline Dimensions

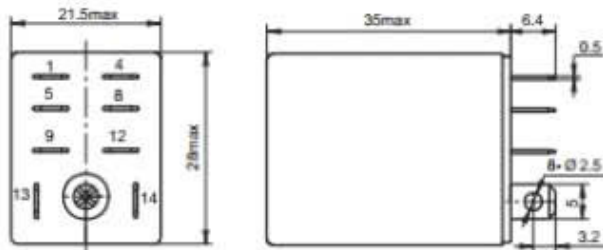

Wiring Diagram

(Bottom view)

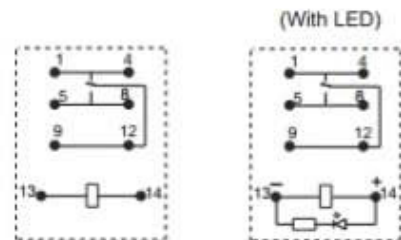

Remark: For AC parts with diode, the positive and negative pole markings on wiring diagram are not applicable.

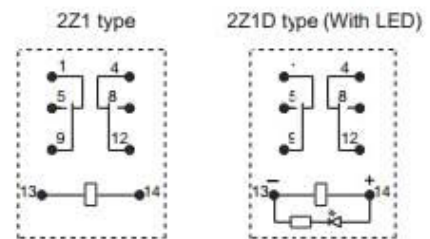
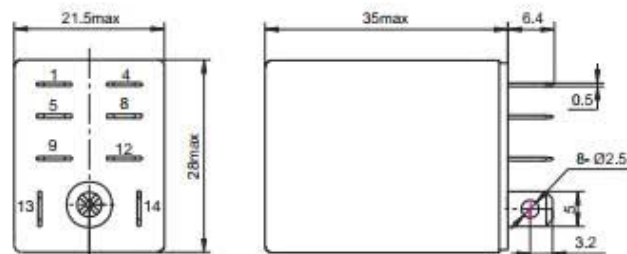

Remark: For AC parts with diode, the positive and negative pole markings on wiring diagram are not applicable.

Outline Dimensions

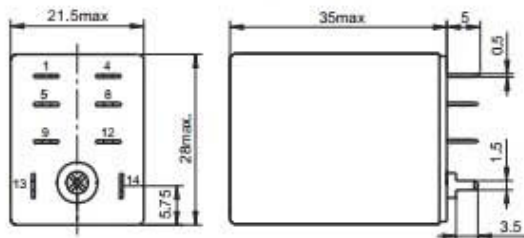

Wiring Diagram

(Bottom view)

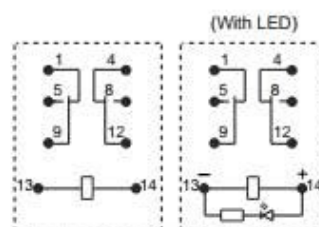

PCB Layout

(Bottom view)

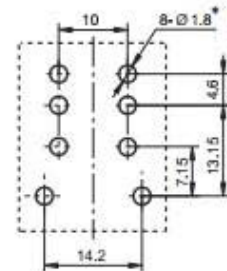

Outline Dimensions

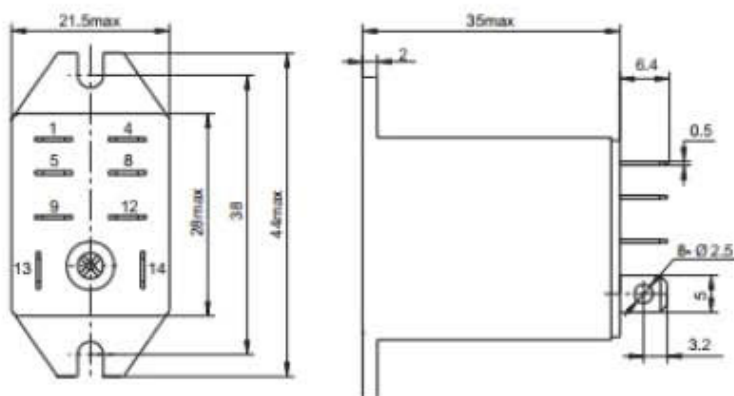

Mounting holes

